



**62 Our catering sinks designs**

**63 Straight edges Comfort catering sinks**

- 64 Catering sinks with sink cover
- 65 Catering sinks without sink cover
- 66 Special dishwasher
- 66 Pastry sink
- 67 Sink units

**69 Rounded edge catering sinks**

- 70 Standard catering sinks
- 71 Customized catering sinks
- 72 Standard suspended and semi-suspended catering sinks
- 73 Sink units
- 74 Special dishwasher
- 75 Standard pot washing sinks
- 76 Customized pot washing sinks

**77 Sinks with square welded bases**

- 78 Basic sinks with sink cover
- 79 Basic sinks with sink cover and bottom shelf

**80 Options**

**82 Accessories**



# CATERING SINKS

Straight edges – Comfort



Rounded edge



Square welded bases – Tradition



**SCAN ME** and download  
all the technical datasheets of the range!

# OUR CATERING SINKS DESIGNS

The performance of our equipment is based on a careful selection of materials. To help you make an informed decision, find out how we use 304L and 441 stainless steel in each of our catering sinks designs.



## Range of catering sinks with straight edges

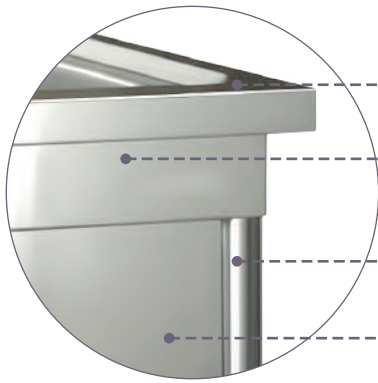

Work top in **304L stainless steel** with straight non-drip edges, dropped 40 mm.

Full **304L stainless steel** header incorporating the «Turn'Fix» system for removable legs.

Removable «Turn'Fix» legs made of **441 stainless steel** tubes, Ø38 mm.

Sink cover in **304L stainless steel**.

## Range of rounded edge catering sinks

Worktop in **304L stainless steel** with rounded non-drip edges, dropped 60 mm.

Full **304L stainless steel** header incorporating the «Turn'Fix» system for removable legs.

Removable «Turn'Fix» legs made of **441 stainless steel** tubes, Ø38 mm.

Sink cover in **304L stainless steel**.

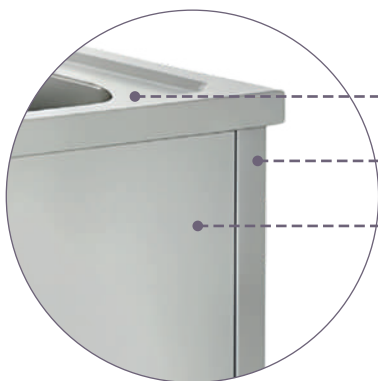

## Range of catering sinks with welded square legs

Work top in **304L stainless steel** with non-drip edges.

Square legs welded from 40x40 mm **441 stainless steel** tubing.

Sink cover in **441 stainless steel**.

# CATERING SINKS

## Catering sinks with straight edges – Comfort

The “*Comfort*” range is designed for smallscale catering sites as well as restaurants. Functional, this range is designed to offer an excellent quality/price ratio with a limited number of items.



**SCAN ME**  
and download all the technical  
datasheets of the range!

- Work top in stainless steel with non-drip edges
- Drainer: grooved
- Supplied with plug, simple overflow pipe and PVC U bend
- Tap hole Ø 31 mm (optional : chromed cover)



- All stainless steel work top = increased longevity
- All stainless steel panel = cleanability and durability

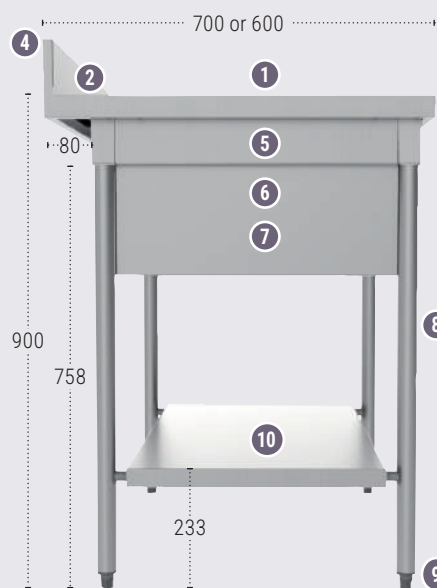

- 1 Work top in stainless steel
- 2 Straight edges
- 3 **Straight edges dropped 40 mm.** Welded corners.
- 4 Flat backsplash (100 x l. 20 mm) rear not closed
- 5 All stainless steel panel
- 6 Sink: 500 x 500 x 300 mm / 500 x 400 x 300 mm
- 7 Sink cover in option
- 8 Tubular stainless steel legs, Ø 38 mm, collapsible
- 9 ABS feet adjustable up to 30 mm
- 10 Bottom shelf EG type (option)

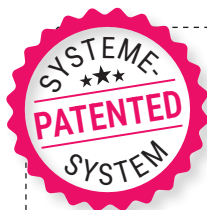

### turn'fix

**Tool-free mounting of the legs,  
easy and quick**



**SCAN ME**  
for the turn'fix  
video!

- 1 Easier
- 2 Quicker
- 3 More robust

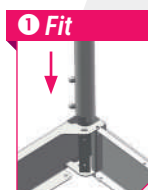



## Catering sinks with sink cover width 600/700 mm

- Sink cover on 3 sides
  - On ABS adjustable feet
  - Optional full bottom shelf.
- Racks bottom shelf see page 80



Sink cover mounted, legs dismantled



### With sink L 500 x W 400 x H 300 mm

WIDTH 600						
Designation	HEIGHT 900 mm L x W mm	SINK WITH SINK COVER		OPTIONAL SHELF supplied with sink		
		Kg	Ref.	Kg	Ref.	
1 bowl + right drainer	1200 x 600	31	<b>PNP112D</b>	6.5	<b>EG612</b>	
1 bowl + left drainer	1200 x 600	31	<b>PNP112G</b>	6.5	<b>EG612</b>	
2 bowls	1200 x 600	33	<b>PNP212</b>	6.5	<b>EG612</b>	
1 bowl + right drainer	1400 x 600	40	<b>PNP114D</b>	7.5	<b>EG614</b>	
1 bowl + left drainer	1400 x 600	40	<b>PNP114G</b>	7.5	<b>EG614</b>	
2 bowls + right drainer	1800 x 600	43	<b>PNP218D</b>	9.5	<b>EG618</b>	
2 bowls + left drainer	1800 x 600	43	<b>PNP218G</b>	9.5	<b>EG618</b>	

Shipping within 48h

### With sink L 500 x W 500 x H 300 mm

WIDTH 700						
Designation	HEIGHT 900 mm L x W mm	SINK WITH SINK COVER		OPTIONAL SHELF supplied with sink		
		Kg	Ref.	Kg	Ref.	
1 bowl	700 x 700	30	<b>PP107</b>	4	<b>EG707</b>	
1 bowl + right drainer	1200 x 700	33	<b>PP112D</b>	8	<b>EG712</b>	
1 bowl + left drainer	1200 x 700	33	<b>PP112G</b>	8	<b>EG712</b>	
2 bowls + right drainer	1600 x 700	40	<b>PP216D</b>	11	<b>EG716</b>	
2 bowls + left drainer	1600 x 700	40	<b>PP216G</b>	11	<b>EG716</b>	
2 bowls + right drainer	1800 x 700	46	<b>PP218D</b>	12.5	<b>EG718</b>	
2 bowls + left drainer	1800 x 700	46	<b>PP218G</b>	12.5	<b>EG718</b>	

Shipping within 48h

OPTIONS  
pages 80-81



ACCESSORIES  
page 82





## Catering sinks without sink cover width 600/700 mm

- Supplied collapsed
- On ABS adjustable feet

- Optional full bottom shelf.  
Racks bottom shelf see page 80

**+** Tool-free mounting of the legs



### With sink L 500 x W 400 x H 300 mm

WIDTH 600						
Designation	HEIGHT 900 mm L x W mm	SINK WITH SINK COVER		OPTIONAL SHELF supplied with sink		
		Kg	Ref.	Kg	Ref.	
1 bowl + right drainer	1200 x 600	21	<b>PN112D</b>	6.5	<b>EG612</b>	
1 bowl + left drainer	1200 x 600	21	<b>PN112G</b>	6.5	<b>EG612</b>	
2 bowls	1200 x 600	19	<b>PN212</b>	6.5	<b>EG612</b>	
1 bowl + right drainer	1400 x 600	22	<b>PN114D</b>	7.5	<b>EG614</b>	
1 bowl + left drainer	1400 x 600	22	<b>PN114G</b>	7.5	<b>EG614</b>	
2 bowls + right drainer	1800 x 600	29	<b>PN218D</b>	9.5	<b>EG618</b>	
2 bowls + left drainer	1800 x 600	29	<b>PN218G</b>	9.5	<b>EG618</b>	

Shipping within 48h

### With sink L 500 x W 500 x H 300 mm

WIDTH 700						
Designation	HEIGHT 900 mm L x W mm	SINK WITH SINK COVER		OPTIONAL SHELF supplied with sink		
		Kg	Ref.	Kg	Ref.	
1 bowl	700 x 700	13	<b>P107</b>	4	<b>EG707</b>	
1 bowl + right drainer	1200 x 700	23	<b>P112D</b>	8	<b>EG712</b>	
1 bowl + left drainer	1200 x 700	23	<b>P112G</b>	8	<b>EG712</b>	
2 bowls + right drainer	1600 x 700	29	<b>P216D</b>	11	<b>EG716</b>	
2 bowls + left drainer	1600 x 700	29	<b>P216G</b>	11	<b>EG716</b>	
2 bowls + right drainer	1800 x 700	32	<b>P218D</b>	12.5	<b>EG718</b>	
2 bowls + left drainer	1800 x 700	32	<b>P218G</b>	12.5	<b>EG718</b>	

Shipping within 48h

**OPTIONS**  
pages 80-81



**ACCESSORIES**  
page 82





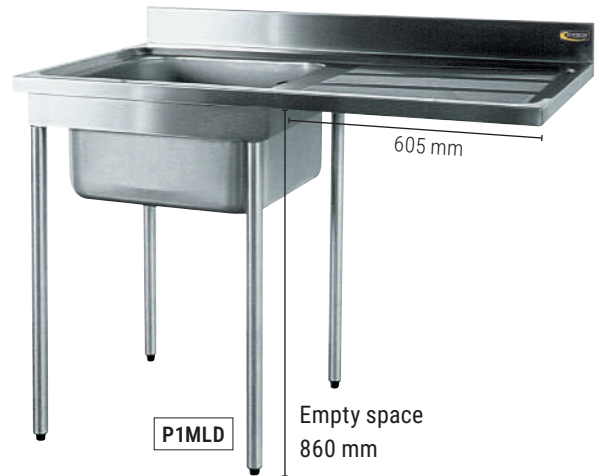

## Special dishwasher sink

- For dishwashers (600 x 600 x 860 mm)
- Same as sinks page 64, with empty space under drainer
- Optional shelf: only under sink

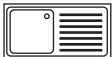

### WIDTH 700

Designation	HEIGHT 900 mm L x W mm	SINK WITHOUT SINK COVER		SINK WITH SINK COVER		OPTIONAL SHELF supplied with sink	
		Kg	Ref.	Kg	Ref.	Kg	Ref.
 1 bowl + right drainer	1200 x 700	21.5	<b>P1MLD</b>	26	<b>PP1MLD</b>	4	<b>EG712ML</b>
 1 bowl + left drainer	1200 x 700	21.5	<b>P1MLG</b>	26	<b>PP1MLG</b>	4	<b>EG712ML</b>
 2 bowls + right drainer	1800 x 700	31	<b>P2MLD</b>	39	<b>PP2MLD</b>	8	<b>EG718ML</b>
 2 bowls + left drainer	1800 x 700	31	<b>P2MLG</b>	39	<b>PP2MLG</b>	8	<b>EG718ML</b>

 Shipping within 48h

## Pastry sink



- Entirely in stainless steel, 1.5 mm thickness
- Acute angles
- Sink dimensions: L 780 x W 480 x H 400 mm
- Supplied with plug and overflow pipe
- Tap hole Ø 31 mm
- Rear backsplash H 60 mm

**+** Ideally for pastry plates 600x400 and mixer bowls

Designation	L x D x H mm	Kg without shelf	Ref.
Sink	850 x 600 x 850	27	<b>PLS</b>
Single removable drainer	600 x 600	4	<b>PLSES</b>
Drainer with shelf	600 x 600 x 850	10	<b>PLSEE</b>

**OPTIONS**  
pages 80-81



**ACCESSORIES**  
page 82





## Sink units width 600 and 700 mm

- Work top in stainless steel with non-drip edges and back splash 100 x 20 mm
- On ABS feet
- Drainer: grooved
- Half-sized back to insert pipework
- 2 hanging sliding doors
- **With lock**
- Supplied with plug, simple overflow pipe and PVC U bend
- Tap hole Ø 31 mm
- Without shelf

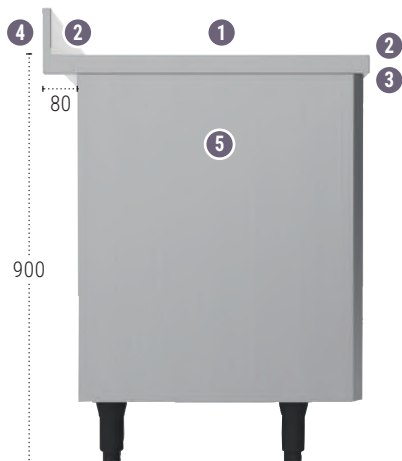

- 1 Work top in stainless steel
- 2 Straight edges
- 3 **Straight edges dropped 40 mm.** Welded corners.
- 4 Flat back splash 100 x 20 mm rear not closed
- 5 All stainless steel
- 6 Black composite feet H 155 mm adjustable up to 70 mm



**Ergonomics:** Cut sections to strengthen the side walls (registered design)  
**Safety:** crush folds

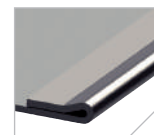

### With sink L 500 x W 400 x H 300 mm



WIDTH 600				
	Designation	L x D x H mm	Kg	Ref.
	1 bowl + right drainer	1200 x 600 x 900	41	<b>MPN112D</b>
	1 bowl + left drainer	1200 x 600 x 900	41	<b>MPN112G</b>
	2 bowls	1200 x 600 x 900	43	<b>MPN212</b>
	1 bowl + right drainer	1400 x 600 x 900	46	<b>MPN114D</b>
	1 bowl + left drainer	1400 x 600 x 900	46	<b>MPN114G</b>
	2 bowls + right drainer	1800 x 600 x 900	56	<b>MPN218D</b>
	2 bowls + left drainer	1800 x 600 x 900	56	<b>MPN218G</b>

### Avec bac de L 500 x L 500 x P 300 mm



WIDTH 700				
	Designation	L x W x H mm	Kg	Ref.
	1 bowl + right drainer	1200 x 700 x 900	45	<b>MP112D</b>
	1 bowl + left drainer	1200 x 700 x 900	45	<b>MP112G</b>
	2 bowls + right drainer	1600 x 700 x 900	61	<b>MP216D</b>
	2 bowls + left drainer	1600 x 700 x 900	61	<b>MP216G</b>
	2 bowls + right drainer	1800 x 700 x 900	68	<b>MP218D</b>
	2 bowls + left drainer	1800 x 700 x 900	68	<b>MP218G</b>

**Shipping within 48h**

**ACCESSORIES**  
page 82



OPTION for sink units	Ref.
4 stainless steel feet - Add X to the end of the reference	<b>...X</b>
4 stainless steel castors - Add X to the end of the reference, <b>only on sink units width 700 mm</b>	<b>.../RX</b>

# Stainless steel, the material of chefs

## The specificity of stainless steel

When exposed to moisture in the air or water, steel rusts, unlike stainless steel, which contains chromium.

With the exception of precious metals such as gold or platinum, all metals are extracted from ore. Over time, they therefore tend to return to their original state, i.e. oxides.

Passive film = protective layer

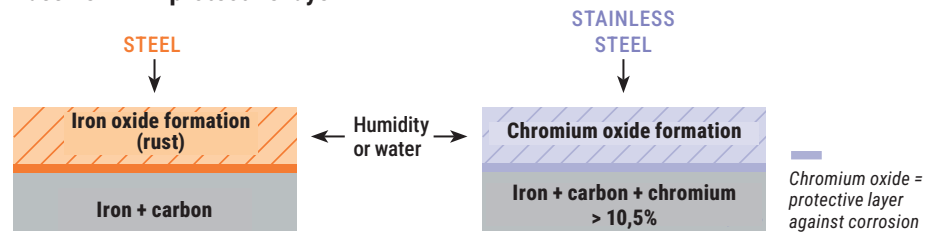

Because steel does not contain chromium, on contact with moist air or water, an iron oxide called rust is formed on the surface.

Conversely, because it contains chromium, a protective layer of chromium oxide called a passive film forms naturally on the surface of stainless steel, protecting it from corrosion.



Around the world, the vast majority of professional kitchen equipment is made of stainless steel, an ideal material due to its many properties.

- Food
- Hygienic
- Heat resistant
- Shock resistant
- Aesthetics
- Cleanable
- Corrosion resistant
- Sustainable



## How to extend the life of your stainless steel equipment?

Regular maintenance helps to preserve the original appearance of stainless steel and ensure its resistance to corrosion.

### ✓ Maintenance

- Clean and rinse regularly with WATER
- Dry after use
- **Use suitable products:** water and mild soap, a soft sponge or cloth, white vinegar, a cleaner specifically formulated for stainless steel
- Use plastic or wooden utensils to avoid damaging surfaces

### ✗ Caution!

- Do not use ABRASIVE products such as sponges or metal brushes
- Do not use concentrated and/or hot bleach or chlorine
- Do not allow acidic liquids to remain in contact with stainless steel
- Do not use wax or polishing agents
- Do not use sharp objects or hard metal objects

# CATERING SINKS

## Rounded edge catering sinks

The rounded edge range meet the requirements of the architects and kitchen consultants for the tenders.



SCAN ME and download all the technical datasheets of the range!



### FOCUS ON...



Welded corners



Sloped backplash

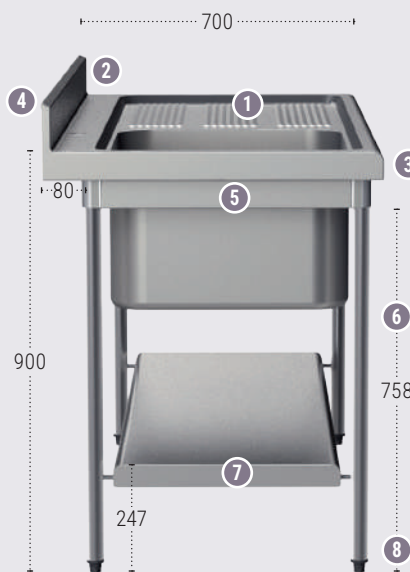

- 1 Work top in AISI 304L stainless steel 1.5 mm thickness
- 2 10 mm curve
- 3 Welded corners, 20 mm radius, front rounded edge, 60 mm thick work top
- 4 Backsplash with 30° slope edge 100 x 20 mm (optional: rear closed)
- 5 100% stainless steel body
- 6 Tubular stainless steel feet, Ø 38 mm, collapsible
- 7 Rounded edge removable bottom shelf, EGA type, optional
- 8 ABS feet adjustable up to 30 mm



## turn'fix

Quick and safe tool  
free assembly

- ☐ Easier
- ☐ Quicker
- ☐ More robust



SCAN ME for the turn'fix video!

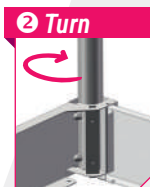
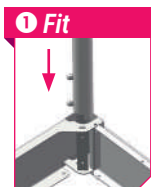

Bottom shelf slots into the legs in a single movement. No more useless handling of the table





# CATERING SINKS | ROUNDED EDGE CATERING SINKS

## Standard rounded edge catering sinks width 700 mm



ASSEMBLED SINK COVER,  
DISMANTLED FEET

- On ABS adjustable feet
- Optional rounded edge 1.5 mm thickness bottom shelf
- Racks bottom shelf see page 80

## With bowl(s) L 500 x W 500 x H 300 mm - Especially for the kitchen

Standard	HEIGHT 900 mm	CATERING SINK WITHOUT SINK COVER supplied unassembled	CATERING SINK WITH SINK COVER supplied assembled	OPTIONAL SHELF supplied with sink			
				WIDTH 700			
Designation	L x W mm	Kg	Ref.	Kg	Ref.	Kg	Ref.
1 bowl	700 x 700	26	PA107	28	PAP107	5	EGA707
1 bowl + right drainer	1200 x 700	32	PA112D	35	PAP112D	8	EGA712
1 bowl + left drainer	1200 x 700	32	PA112G	35	PAP112G	8	EGA712
2 bowls	1200 x 700	36	PA212	39	PAP212	8	EGA712
2 bowls + right drainer	1600 x 700	40	PA216D	45	PAP216D	11.5	EGA716
2 bowls + left drainer	1600 x 700	40	PA216G	45	PAP216G	11.5	EGA716
2 bowls + right drainer	1800 x 700	44	PA218D	50	PAP218D	12.5	EGA718
2 bowls + left drainer	1800 x 700	44	PA218G	50	PAP218G	12.5	EGA718
2 bowls + 2 drainers	2100 x 700	64	PA221	71	PAP221	14	EGA721

Shipping within 48h

## With bowl(s) L 600 x W 500 x H 300 mm

Standard	HEIGHT 900 mm	CATERING SINK WITHOUT SINK COVER supplied unassembled	CATERING SINK WITH SINK COVER supplied assembled	OPTIONAL SHELF supplied with sink			
				WIDTH 700			
Designation	L x W mm	Kg	Ref.	Kg	Ref.	Kg	Ref.
1 bowl	800 x 700	27	PA108	29	PAP108	5.5	EGA708
1 bowl + right drainer	1400 x 700	34	PA114D	37	PAP114D	9.5	EGA714
1 bowl + left drainer	1400 x 700	34	PA114G	37	PAP114G	9.5	EGA714
2 bowls	1400 x 700	38	PA214	41	PAP214	9.5	EGA714
1 bowl + right drainer	1500 x 700	40	PA115D	45	PAP115D	10.5	EGA715
1 bowl + left drainer	1500 x 700	40	PA115G	45	PAP115G	10.5	EGA715
2 bowls	1500 x 700	42	PA215	47	PAP215	10.5	EGA715
2 bowls + right drainer	1900 x 700	46	PA219D	52	PAP219D	13	EGA719
2 bowls + left drainer	1900 x 700	46	PA219G	52	PAP219G	13	EGA719
2 bowls + 2 drainers + shelf, 6 feet	2400 x 700	68	PA224	74	PAP224	-	-

Shipping within 48h

OPTIONS  
pages 80-81



ACCESSORIES  
page 82





## Customized rounded edge catering sinks without sink cover



- Top in AISI 304L stainless steel 1.5 mm thickness, with non-drip edges
- Ribbed drainer. Smooth drainer optional (page 80)
- With sink cover optional (page 80)
- Backsplash with 30° slope edge, 100 x 20 mm (rear closure optional page 80)
- 20 mm radius front rounded edge, 60 mm thick work top
- Tubular ABS feet Ø 38 mm
- 6 feet from length : 2200 mm
- Supplied with plug, simple overflow pipe and PVC U bend
- Specify when ordering side drainer and sink(s) position



Our catering sinks are delivered with tap hole Ø 31 mm.  
Without tap hole or with 2 tap holes : see options SPST and SPBT page 80.

### With bowl(s) L 500 x W 500 x H 300 mm

Customized		HEIGHT 900 mm	SINK	OPTIONAL SHELF supplied with sink	
WIDTH 700					
Designation	Nb of sink	Nb of drainer	Dimension top of catering sink mm	Ref.	Ref.
	1	0	750 to 799	PA155-08	EGA7-08
	1	0	800 to 1000	PA155-10	EGA7-10
	1	1	1000 to 1199	PA155-12	EGA7-12
	1	1	1250 to 1400	PA155-14	EGA7-14
	2	0	1250 to 1399	PA255-14	EGA7-14
	2	0	1400 to 1599	PA255-16	EGA7-16
	2	1	1650 to 1799	PA255-18	EGA7-18
	2	1	1850 to 1999	PA255-20	EGA7-20
	2	1	2000 to 2100	PA255-21	EGA7-21
	2	2	2150 to 2400	PA255-24	EGA7-24

### With bowl(s) L 600 x W 500 x H 300 mm

Customized		HEIGHT 900 mm	SINK	OPTIONAL SHELF supplied with sink	
WIDTH 700					
Designation	Nb of sink	Nb of drainer	Dimension top of catering sink mm	Ref.	Ref.
	1	0	850 to 999	PA165-10	EGA7-10
	1	0	1000 to 1199	PA165-12	EGA7-12
	1	1	1200 to 1399	PA165-14	EGA7-14
	2	0	1550 to 1599	PA265-16	EGA7-16
	2	0	1600 to 1899	PA265-19	EGA7-19
	2	1	1950 to 2100	PA265-21	EGA7-21
	2	2	2150 to 2399	PA265-24	EGA7-24
	2	2	2450 to 2600	PA265-26	EGA7-26



## Standard suspended and semi-suspended catering sinks

### Suspended version (same as sinks on feet):

- Work top : in AISI 304L 1.5 mm thickness stainless steel
- Frame in bent round stainless steel tube Ø 38 mm
- Frame fixed to the wall by screwing through the wall plates
- Top attaches to the wall by screwing of the rear profile
- Tap hole Ø 31 mm (optional cover)

### Semi-suspended version:

- Frame in bent round stainless steel tube Ø 38 mm with welded legs
- Frame fixed to the wall by screwing through the wall plates
- Top attaches to the wall by screwing of the rear profile



Time saving of cleaning floor

With bowl(s) L 500 x W 500 x H 300 mm

### Standard



		SUSPENDED VERSION		SEMI-SUSPENDED VERSION	
Designation	L x W mm	Kg	Ref.	Kg	Ref.
1 bowl	700 x 700	21	<b>PAS107</b>	22	<b>PASS107</b>
1 bowl + right drainer	1200 x 700	36	<b>PAS112D</b>	37	<b>PASS112D</b>
1 bowl + left drainer	1200 x 700	36	<b>PAS112G</b>	37	<b>PASS112G</b>
2 bowls	1200 x 700	36	<b>PAS212</b>	37	<b>PASS212</b>
2 bowls + right drainer	1600 x 700	48	<b>PAS216D</b>	49	<b>PASS216D</b>
2 bowls + left drainer	1600 x 700	48	<b>PAS216G</b>	49	<b>PASS216G</b>
2 bowls + right drainer	1800 x 700	54	<b>PAS218D</b>	55	<b>PASS218D</b>
2 bowls + left drainer	1800 x 700	54	<b>PAS218G</b>	55	<b>PASS218G</b>
2 bowls + 2 drainers	2100 x 700	53	<b>PAS221</b>	54	<b>PASS221</b>

Avec bac(s) de L 600 x L 500 x P 300 mm

		SUSPENDED VERSION		SEMI-SUSPENDED VERSION	
Designation	L x W mm	Kg	Ref.	Kg	Ref.
1 bowl	800 x 700	24	<b>PAS108</b>	25	<b>PASS108</b>
1 bowl + right drainer	1400 x 700	39	<b>PAS114D</b>	40	<b>PASS114D</b>
1 bowl + left drainer	1400 x 700	39	<b>PAS114G</b>	40	<b>PASS114G</b>
2 bowls	1400 x 700	39	<b>PAS214</b>	40	<b>PASS214</b>
1 bowl + right drainer	1500 x 700	45	<b>PAS115D</b>	46	<b>PASS115D</b>
1 bowl + left drainer	1500 x 700	45	<b>PAS115G</b>	46	<b>PASS115G</b>
2 bowls	1500 x 700	45	<b>PAS215</b>	46	<b>PASS215</b>
2 bowls + right drainer	1900 x 700	57	<b>PAS219D</b>	58	<b>PASS219D</b>
2 bowls + left drainer	1900 x 700	57	<b>PAS219G</b>	58	<b>PASS219G</b>
2 bowls + 2 drainers (3 tubes)	2400 x 700	65	<b>PAS224</b>	68	<b>PASS224</b>

Shipping within 48h

► **CUSTOMIZED** / Select a custom top module page 71 and add the TOP16 and TOP17 options page 80

**OPTIONS**  
pages 80-81



**ACCESSORIES**  
page 82





## Sink units

- Drainer: grooved with non-drip edges
- Half-sized back to insert pipework
- 2 hanging sliding doors
- Lock
- Supplied with plug, simple overflow pipe and PVC U bend
- Tap hole Ø 31 (optional cover p. 82)
- No inner shelf
- On ABS feet



- 1 Work top in 15/10<sup>th</sup> (1.5 mm) thick with anti drip edge
- 2 10 mm curve
- 3 Welded corners with 20 mm radius front rounded edge and 60 mm thick work top
- 4 Backsplash with 30° slope edge (100 x 20 mm)
- 5 All stainless steel
- 6 155 mm ABS feet with adjustable height on 70 mm



**Ergonomics:** Cut angles to strengthen the body of the sink furniture  
**Safety:** crushed folds

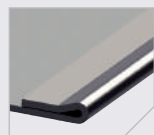

**OPTIONS**  
pages 80-81



**ACCESSORIES**  
page 82



MPA112G



MPA214



MPA216G



MPA224 (4 sliding doors and 2 cases)

## With bowl(s) L 500 x W 500 x H 300 mm

### WIDTH 700

Designation	HEIGHT 900 mm	SINGLE PANEL DOORS AND SIDES		DOUBLE PANEL DOORS AND SIDES	
		L x W mm	Kg	Ref.	Ref.
1 bowl + right drainer		1200 x 700	45	MPA112D	MPA3112D
1 bowl + left drainer		1200 x 700	45	MPA112G	MPA3112G
2 bowls		1200 x 700	45	MPA212	MPA3212
2 bowls + right drainer		1600 x 700	61	MPA216D	MPA3216D
2 bowls + left drainer		1600 x 700	61	MPA216G	MPA3216G
2 bowls + right drainer		1800 x 700	68	MPA218D	MPA3218D
2 bowls + left drainer		1800 x 700	68	MPA218G	MPA3218G
2 bowls + 2 drainers		2100 x 700	90	MPA221	MPA3221

## With bowl(s) L 600 x W 500 x H 300 mm

### WIDTH 700

Designation	HEIGHT 900 mm	SINGLE PANEL DOORS AND SIDES		DOUBLE PANEL DOORS AND SIDES	
		L x W mm	Kg	Ref.	Ref.
1 bowl + right drainer		1400 x 700	53	MPA114D	MPA3114D
1 bowl + left drainer		1400 x 700	53	MPA114G	MPA3114G
2 bowls		1400 x 700	53	MPA214	MPA3214
1 bowl + right drainer		1500 x 700	57	MPA115D	MPA3115D
1 bowl + left drainer		1500 x 700	57	MPA115G	MPA3115G
2 bowls		1500 x 700	57	MPA215	MPA3215
2 bowls + right drainer		1900 x 700	84	MPA219D	MPA3219D
2 bowls + left drainer		1900 x 700	84	MPA219G	MPA3219G
2 bowls + 2 drainers*		2400 x 700	107	MPA224	MPA3224

Shipping within 48h

\* Unit with 4 sliding doors and 2 cases

► CUSTOMIZED : CONSULT US



## Special dishwasher sink







PA1MLD + EGA712ML

- For dishwashers (W 600 x D 600 x H 840 mm)
- Top in AISI 304L stainless steel with non-drip edges, 20 mm radius front rounded edge, 60 mm thick work top
- Backsplash with 30° slope edge 100 X 20 mm (rear closure optional)
- Tubular stainless steel feet Ø 38 mm, can be dismantled
- ABS feet adjustable up to 30 mm
- Draining board : grooved
- Supplied with plug, simple overflow pipe and PVC U bend
- Tap hole Ø 31 mm (optional cover p. 82)
- Empty space under drainer
- Optional shelf: only under sink

## Sink without front and side panels - Bowl(S) L 500 x W 500 x H 300 mm

### WIDTH 700

Designation	HEIGHT 900 mm L x W mm	SINK WITHOUT FRONT AND SIDE PANELS		OPTIONAL SHELF supplied with sink	
		Kg	Ref.	Kg	Ref.
 1 bowl + right drainer	1200 x 700	36	<b>PA1MLD</b>	8	<b>EGA712ML</b>
 1 bowl + left drainer	1200 x 700	36	<b>PA1MLG</b>	8	<b>EGA712ML</b>
 2 bowls + right drainer	1800 x 700	54	<b>PA2MLD</b>	12.5	<b>EGA718ML</b>
 2 bowls + left drainer	1800 x 700	54	<b>PA2MLG</b>	12.5	<b>EGA718ML</b>

## Sink with front and side panels - Bowl(s) L 500 x W 500 x H 300 mm

### WIDTH 700

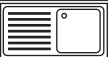
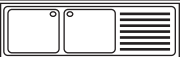
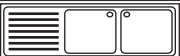
Designation	HEIGHT 900 mm L x W mm	SINK WITH FRONT AND SIDE PANELS		OPTIONAL SHELF supplied with sink	
		Kg	Ref.	Kg	Ref.
 1 bowl + right drainer	1200 x 700	36	<b>PAP1MLD</b>	8	<b>EGA712ML</b>
 1 bowl + left drainer	1200 x 700	36	<b>PAP1MLG</b>	8	<b>EGA712ML</b>
 2 bowls + right drainer	1800 x 700	54	<b>PAP2MLD</b>	12.5	<b>EGA718ML</b>
 2 bowls + left drainer	1800 x 700	54	<b>PAP2MLG</b>	12.5	<b>EGA718ML</b>

 Shipping within 48h

OPTIONS  
pages 80-81



ACCESSORIES  
page 82





## Standard pot sinks



PQ7115D + EGQ715

- Top : AISI304 L stainless steel - Thickness 15/10th ( 1.5 mm ) with anti drip edges
- Front edge : 20 mm radius, 60 mm thick work top
- Backsplash 100 x 20 mm, 30° slope edge, closed sides (optional rear cover). 10 mm radius at the base
- Drainage : ribbed
- Faucet hole : 31 mm (optional cover page 82)
- Base : welded stainless steel frame in square tubes 35 x 35 mm , with ABS feet adjustable on 30 mm (6 feet for 2400 mm length)
- Delivered with plug, overflow tube and PVC U Bend



BIG BOWLS = IDEAL FOR BIG POTS

## Width 700 mm - With bowl(s) L 800 x W 500 x H 375 mm

Standard		HEIGHT 900 mm	POT SINK	OPTIONAL FULL SHELF WITH STRAIGHT EDGES		
WIDTH 700						
Designation	Nb of feet	L x W mm	Kg	Ref.	Kg	Ref.
1 bowl	4	1000 x 700	17	<b>PQ7110</b>	7.6	<b>EGQ710</b>
1 bowl + right drainer	4	1500 x 700	25	<b>PQ7115D</b>	11	<b>EGQ715</b>
1 bowl + left drainer	4	1500 x 700	25	<b>PQ7115G</b>	11	<b>EGQ715</b>
2 bowls	4	1800 x 700	47	<b>PQ7218</b>	13.6	<b>EGQ718</b>
2 bowls + right drainer	6	2400 x 700	41	<b>PQ7224D</b>	18	<b>EGQ724</b>
2 bowls + left drainer	6	2400 x 700	41	<b>PQ7224G</b>	18	<b>EGQ724</b>

## Width 800 mm - With bowl(s) L 800 x W 600 x H 450 mm

Standard		HEIGHT 900 mm	POT SINK	OPTIONAL FULL SHELF WITH STRAIGHT EDGES		
WIDTH 800						
Designation	Nb of feet	L x W mm	Kg	Ref.	Kg	Ref.
1 bowl + right drainer	4	1500 x 800	28	<b>PQ8115D</b>	13	<b>EGQ815</b>
1 bowl + left drainer	4	1500 x 800	28	<b>PQ8115G</b>	13	<b>EGQ815</b>
2 bowls + right drainer	6	2400 x 800	46	<b>PQ8224D</b>	20	<b>EGQ824</b>
2 bowls + left drainer	6	2400 x 800	46	<b>PQ8224G</b>	20	<b>EGQ824</b>

► **CUSTOMIZED** / See our customized pot sinks page 76

OPTIONS  
pages 80-81



ACCESSORIES  
page 82





## Customized pot sinks

- Top 1.5 mm thickness, with non-drip edges
- 20 mm radius front rounded edge, 60 mm thick work top
- Backsplash with 30° slope edge, 100 x 20 mm – radius 10 mm at the bottom of the backsplash
- Ribbed drainer (smooth drainer in option page 80)
- 1 tap hole Ø 31 mm. Possible without hole or with 2 holes : see options page 80.
- Frame and feet : welded frame in 35 x 35 mm square tubular stainless steel with front and side panels
- Supplied with plug, simple overflow pipe and PVC U bend
- 4 ABS feet, 6 feet from length 2200 mm



PQ185-15



PQ186-18 + EGQ8-18

### Width 700 mm - With bowl(s) L 800 x W 500 x H 375 mm

Customized			HEIGHT 900 mm	POT SINK	OPTIONAL SHELF supplied with sink
WIDTH 700					
Designation	Nb of sink	Nb of drainer	Dimension top of catering sink mm	Ref.	Ref.
	1	0	1050 to 1399	PQ185-14	EGQ7-14
	1	1	1400 to 1499	PQ185-15	EGQ7-15
	1	1	1550 to 1800	PQ185-18	EGQ7-18
	2	0	1850 to 2099	PQ285-21	EGQ7-21
	2	0	2100 to 2399	PQ285-24	EGQ7-24
	2	1	2450 to 2600	PQ285-26	EGQ7-26

### Width 800 mm - With bowl(s) L 800 x W 600 x H 450 mm

Customized			HEIGHT 900 mm	POT SINK	OPTIONAL SHELF supplied with sink
WIDTH 800					
Designation	Nb of sink	Nb of drainer	Dimension top of catering sink mm	Ref.	Ref.
	1	0	1050 to 1499	PQ186-15	EGQ8-15
	1	1	1550 to 1799	PQ186-18	EGQ8-18
	2	0	1800 to 1999	PQ286-20	EGQ8-20
	2	0	2000 to 2100	PQ286-21	EGQ8-21
	2	1	2450 to 2600	PQ286-26	EGQ8-26

OPTIONS  
pages 80-81



ACCESSORIES  
page 82



# CATERING SINKS

## Sinks with square welded bases – Tradition

In this tab, we would like to introduce the ranges of traditional sinks range with high robustness square welded bases .



**SCAN ME**  
and download all the technical  
datasheets of the range!



Top and base stainless steel  
All-stainless steel construction  
delivered fully welded and assembled

**FOCUS ON...**



Welded square legs

- 1 Recesses top with antidrip edge
- 2 Width 600 or 700 mm
- 3 Adjustable working height 890/915 mm (overall height: 990/1014 mm)
- 4 100 x 20 mm backsrest completely closed at the ends by welding
- 5 Embossed soundproofed sink with rounded angles and corners
- 6 Ribbed drainer
- 7 Stainless steel legs tubes, sections 40 x 40 mm, on levelers, with stainless steel cladding on all four sides
- 8 Bottom shelf welded to the legs (optional)



## Basic sinks with sink cover

- All-stainless steel construction delivered fully welded and assembled
- Recesses top with antidrip edge
- 100 x 20 mm backsrest completely closed at the ends by welding
- Drilling Ø 30 mm for faucet (not included)
- Embossed soundproofed sink with ounded angles and corners
- Ribbed drainer
- Stainless steel legs tubes, sections 40 x 40 mm, on levelers, with stainlesssteel cladding on all four sides
- Adjustable working height 890/915 mm
- Supplied with stainless steel/plastic drain, stainless steel overflow tube, and PVC trap.

### With sink 400 x 500 x 300 mm



#### Standard

WIDTH 600				
	Designation	L x W mm	Kg	Ref.
	1 bowl + right drainer	1200 x 600	27.6	<b>PFN6112D</b>
	1 bowl + left drainer	1200 x 600	27.6	<b>PFN6112G</b>
	2 bowls	1200 x 600	4	<b>PFN6212</b>
	2 bowls + right drainer	1600 x 600	38.5	<b>PFN6216D</b>
	2 bowls + left drainer	1600 x 600	38.5	<b>PFN6216G</b>

### With sink 500 x 500 x 300 mm



#### Standard

WIDTH 700				
	Designation	L x W mm	Kg	Ref.
	1 bowl + right drainer	1200 x 700	28.8	<b>PFN112D</b>
	1 bowl + left drainer	1200 x 700	28.8	<b>PFN112G</b>
	2 bowls + right drainer	1600 x 700	48.3	<b>PFN216D</b>
	2 bowls + left drainer	1600 x 700	48.3	<b>PFN216G</b>
	2 bowls + right drainer	1800 x 700	45.5	<b>PFN218D</b>
	2 bowls + left drainer	1800 x 700	45.5	<b>PFN218G</b>

### With sink 600 x 500 x 300 mm



#### Standard

WIDTH 700				
	Designation	L x W mm	Kg	Ref.
	1 bowl + right drainer	1400 x 700	33	<b>PFN114D</b>
	1 bowl + left drainer	1400 x 700	33	<b>PFN114G</b>
	2 bowls + right drainer	2000 x 700	48.8	<b>PFN220D</b>
	2 bowls + left drainer	2000 x 700	48.8	<b>PFN220G</b>
	2 bowls + 2 drainers	2400 x 700	60.1	<b>PFN224</b>

► CUSTOMIZED : CONSULT US

ACCESSORIES  
page 82





## Basic sinks with sink cover and bottom shelf

- All-stainless steel construction delivered fully welded and assembled
- Recesses top with antidrip edge
- 100 x 20 mm backsrest completely closed at the ends by welding
- Drilling Ø 30 mm for faucet (not included)
- Embossed soundproofed sink with rounded angles and corners
- Ribbed drainer
- Stainless steel legs tubes, sections 40 x 40 mm, on levelers, with stainless steel cladding on all four sides
- Adjustable working height 890/915 mm
- Supplied with stainless steel/plastic drain, stainless steel overflow tube, and PVC trap

### With sink 400 x 500 x 300 mm



#### Standard

WITH BOTTOM SHELF





WIDTH 600				
Designation	L x W mm	Kg	Ref.	
 1 bowl + right drainer	1200 x 600	39.8	<b>PFNE6112D</b>	
 1 bowl + left drainer	1200 x 600	40.5	<b>PFNE6112G</b>	
 2 bowls	1200 x 600	40.5	<b>PFNE6212</b>	
 2 bowls + right drainer	1600 x 600	50	<b>PFNE6216D</b>	
 2 bowls + left drainer	1600 x 600	50	<b>PFNE6216G</b>	

### With sink 500 x 500 x 300 mm

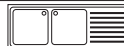

#### Standard

WITH BOTTOM SHELF





WIDTH 700				
Designation	L x W mm	Kg	Ref.	
 1 bowl + right drainer	1200 x 700	38.9	<b>PFNE112D</b>	
 1 bowl + left drainer	1200 x 700	38.9	<b>PFNE112G</b>	
 2 bowls + right drainer	1600 x 700	55.6	<b>PFNE216D</b>	
 2 bowls + left drainer	1600 x 700	55.6	<b>PFNE216G</b>	
 2 bowls + right drainer	1800 x 700	60.6	<b>PFNE218D</b>	
 2 bowls + left drainer	1800 x 700	60.6	<b>PFNE218G</b>	

### With sink 600 x 500 x 300 mm



#### Standard

WITH BOTTOM SHELF

WIDTH 700				
Designation	L x W mm	Kg	Ref.	
 1 bowl + right drainer	1400 x 700	44.7	<b>PFNE114D</b>	
 1 bowl + left drainer	1400 x 700	44.7	<b>PFNE114G</b>	
 2 bowls + right drainer	2000 x 700	65.6	<b>PFNE220D</b>	
 2 bowls + left drainer	2000 x 700	65.6	<b>PFNE220G</b>	

► CUSTOMIZED : CONSULT US

ACCESSORIES  
page 82





## Options for straight edges and rounded edge catering sinks

### Racks bottom shelf

- All stainless steel
- 35 x 35 mm square tube

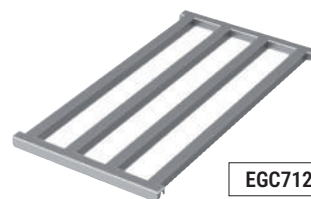

	WIDTH 600 mm		WIDTH 700 mm	
	FOR STRAIGHT EDGES CATERING SINKS		FOR STRAIGHT EDGES AND ROUNDED EDGE CATERING SINKS	
For catering sink length mm	Kg	Ref.	Kg	Ref.
1000	5.2	EGC610	7	EGC710
1200	6	EGC612	8.2	EGC712
1400	6.5	EGC614	9.4	EGC714
1500	7	EGC615	10	EGC715
1600	7.4	EGC616	10.7	EGC716
1800	8	EGC618	12	EGC718
2000	9	EGC620	13.2	EGC720
2200	9.5	EGC622	14.5	EGC722

### Other options

Std : standard,  
CM : customized

Designation	FOR CATERING SINKS WITH				Ref.
	STRAIGHT EDGES	ROUNDED EDGE			
	Std	Std	CM		
<b>Legs / feet &amp; castors</b>					
4 stainless steel feet - Add X to the end of the reference	✓	✓	✓	.../X	
4 stainless steel castors Ø 125 mm (2 with brake) - Add RX to the end of the reference	✓	✓	✓	.../RX	
4 stainless steel feet for sink unit - Add X to the end of the reference	Sink unit	Sink unit	Sink unit	.../X	
4 stainless steel castors for sink unit width 700 mm only, Ø 125 mm (2 with brake) - Add RX to the end of the reference	Sink unit	Sink unit	Sink unit	.../RX	
4 polyamid castors Ø 125 mm (2 with brake) - Add RP to the end of the reference	✓	✓	✓	.../RP	
Semi-mobile option	2 castors polyamid cover without brake and 2 stainless adjustable legs in front - Add SMP to the end of the ref.	✓	✓	✓	.../SMP
	2 castors stainless cover without brake and 2 stainless adjustable legs in front - Add SMX to the end of the ref.	✓	✓	✓	.../SMX
Special height legs For tray height 1050 mm maximum (otherwise consult us). Specify the desired height of the material when ordering	✓	✓		SPHT	
2 hanging consoles (extra cost to add to the price of customized catering sinks on 4 ABS adjustable legs) Price is x1,5 for length upper than 2200 mm (3 consoles)			✓	TOP16	
2 semi-hanging consoles (extra cost to add to the price of customized catering sinks on 4 ABS adjustable legs) Price is x1,5 for length upper than 2200 mm (3 consoles)			✓	TOP17	



# Options for straight edges and rounded edge catering sinks

Std : standard,  
CM : customized

FOR CATERING SINKS WITH

Designation	STRAIGHT EDGES		ROUNDED EDGE		Ref.
	Std		Std	CM	
<b>Structure &amp; reinforcement</b>					
Lateral and longitudinal bottom crosspieces (U or H shape: please notify on the order). <i>Non available on suspended or semi-suspended sinks</i>			✓	✓	TRAV
4 feet welded on the side strips <i>For tables with 6 feet, prices x 1,5</i>			✓	✓	SPSOUD
<b>Panels</b>					
Stainless steel panels (3 faces) for standard suspended and semi-suspended sinks			✓		TOP15
Stainless steel panels (3 faces)				✓	POPT04
Knee operated: for sinks with sink cover from length 1200 mm - Delivered with front panel with pre-mixer, swan neck and push tap	✓		✓	✓	CEAUV
<b>Backsplashes</b>					
Rear backsplash closure		✓	✓	✓	TFD
Side raised backsplash: Welded and siliconed, rear not closed	For sinks width 600 mm	On the right	✓		TTDR610D
		On the left	✓		TTDR610G
	For sinks width 700 mm	On the right	✓		TTDR710D
		On the left	✓		TTDR710G
Side raised backsplash: Welded and siliconed, rear not closed	For sinks width 700 mm	On the right		✓	TTDR710AD
		On the left		✓	TTDR710AG
Rear backsplash height 300 mm (per lm)				✓	POPT14
Manufactured side backsplash 100x20 mm integrated to the top Possibility of adding 2 side sheet metal backsplashes up to 2700 mm. <i>Warning, only 1 side sheet metal backsplash from 2701 to 2800 mm max.</i>				✓	CONSULT US
<b>finishing &amp; worktop</b>					
Vibrated polishing (in circles) (per lm)				✓	TOP10
Smooth drainer				✓	POPT17
Drainer with 2 mm thickness instead of 1.5 mm (per lm)				✓	CONSULT US
Dry zone for waste discharge hole (without TVO - option TTVDC to add with TVO)				✓	CONSULT US
Interior fittings for sink unit - bottom shelf + partition			Sink unit		POPT16



TOP16



TOP17



CEAUV



TTRD710AD

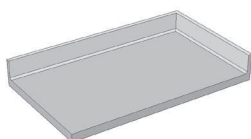

Side raised backsplash



TOP10

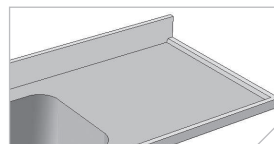

POPT17

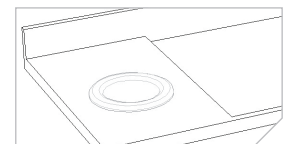

Dry zone for TVD



## Accessories for standard and customized catering sinks

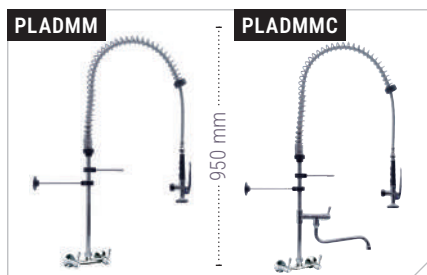
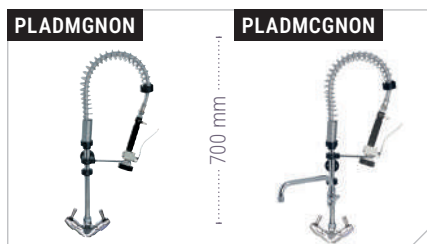
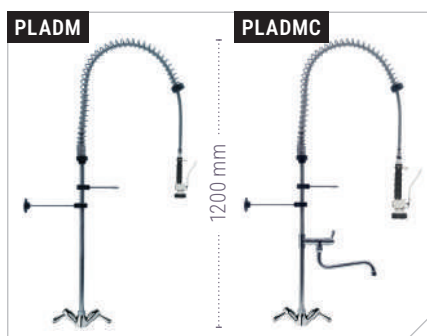

Designation	Ref.
-------------	------

### Faucet to fix on sink

#### Mixer spray-heads to fix on sink Height 1200 mm

Fixed to the table + wall fixing bracket - Stainless steel AISI 304L - Mixer with non-return valves according to European standard EN13959 - Safety spring - Flexible I. 1200 mm in AISI 304L stainless steel braid + EPDM standard, nd 12.5 - Flow rate in liters per minute for a pressure of 3/4 bars: 17 l/min - Total height: 1200 mm - Ergonomic grips with turn valve head - HW/CW taps with high-quality ceramic head - Spray head in stainless steel interior according to European standards CE, ROHS and ACS

Without drawing tap	<b>PLADM</b>
With drawing tap with swivel telescopic spout	<b>PLADMC</b>

#### Mixer spray-heads « Mignon » model Height 700 mm

Ideal to go under the wall cabinets

Without drawing tap	<b>PLADMGNON</b>
With drawing tap with swivel telescopic spout	<b>PLADMCGNON</b>

1/4 turn tap: Single hole with swan's neck	<b>PLARQT1</b>
--	----------------

Mixer tap: Single hole	<b>PLAROBIML</b>
------------------------	------------------

### Wall faucet

#### Wall mixer spray-heads

Idem PLADMC except : wall fixation, height 950 mm

Without drawing tap	<b>PLADMM</b>
With drawing tap with swivel telescopic spout	<b>PLADMMC</b>

#### Wall mixer taps

Twin-hole - 1/4 turn - Wall fixation - Spout length 250 mm

Swivel spout from below	<b>PLARMQT2</b>
Swivel spout from above	<b>PLARMQT3</b>

Chromed cover: For the tap hole	<b>CT50</b>
---------------------------------	-------------

### U bends

PVC	<b>PLASIPHPL</b>
Chromed brass	<b>PLASIPHLA</b>

Plug	PVC	Brass*
<b>Perforated overflow pipe:</b> Makes catching waste easier and prevents the risk of the U bend getting blocked	H180 mm	<b>POPTUB18</b>
	H230 mm	<b>POPTUB23</b>
	H280 mm	<b>POPTUB28</b>
	H350 mm	<b>POPTUB35</b>
	H430 mm	<b>POPTUB43</b>

### Perforated plate for tank bottom heights:

Compatible only with Sofinor catering sinks - With tube hole for overflow - Specify when ordering the position of the drain - If separate order of the plunge, provide the tank rays

For sink 500x400, 500x500 and 600x 500 - Height 100 mm	<b>POGDH</b>
For sink 800x500 and 800x600 - Height 150 mm	<b>POGDHQ</b>

### Straight sink exhaust pipe without tap\*\*:

Tubular 42,4 mm without valve - Non available on sink with integral bottom shelf

Simple	<b>PLAVISV*</b>
Double Y	<b>PLAVIDSV*</b>

### Straight sink exhaust pipe with tap (s)\*\*:

With 1/4 40 x 49 female turn(s) and AISI 304L stainless steel outlet pipe(s) (distance from floor about 80 mm depending on) Non available on sink with integral bottom shelf

Simple	<b>PLAVI*</b>
Double Y	<b>PLAVID*</b>

Shipping within 48h

\*Brass plug required when ordering PLAVI, PLAVID, PLAVISV, PLAVIDSV  
\*\*For the price of offset or angled drains, please consult us